











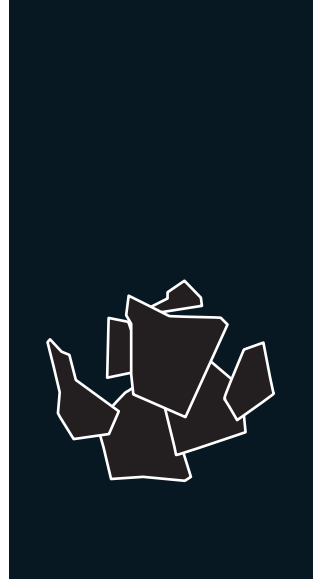

SCALA 3000 THREE PHASE 400 V / 50 Hz

MACHINE À GLACE EN ÉCAILLES

FEATURES CARACTÉRISTIQUES

- ▶ **PRODUCES COLD AND DRY FLAT FLAKES. FLAKE THICKNESS MAY BE ADJUSTED BETWEEN 1.5 MM AND 3 MM.**
PRODUIT DES ÉCAILLES PLATES, TRÈS FROIDES ET SÈCHES. L'ÉPAISSEUR PEUT SE RÉGLER ENTRE 1,5 MM ET 3 MM.
- ▶ **BASED ON A STATIC CYLINDER WHICH IS FREE FROM SWIVEL JOINTS (HELICAL REAMER) COUPLED WITH A MILLING TOOL THAT DETACHES THE ICE WITHOUT ANY STRAINED OR FORCED MOVEMENTS.**
FONCTIONNEMENT BASÉ SUR UN CYLINDRE STATIQUE SANS JOINTS TOURNANTS (HELICAL REAMER) ET AVEC UNE FRAISE QUI DÉCOLLE LA GLACE SANS TENSION NI EFFORTS.
- ▶ **THE MOST EFFICIENT EVAPORATOR OF THE MARKET, LESS ENERGY CONSUMPTION AND HIGHER ICE PRODUCTION.**
L'ÉVAPORATEUR LE PLUS EFFICACE DU MARCHÉ, MOINS DE DÉPENSES ÉNERGÉTIQUES, PLUS PRODUCTION DE GLAÇONS.
- ▶ **ELECTRONIC STOP SYSTEM / ELECTRICAL CONTROL PANEL / DRIVE DIRECT GEAR MOTOR / MAGNETIC DRIVE PUMP / LOW WATER SAFETY DEVICE.**
SYSTÈME D'ARRÊT ÉLECTRONIQUE / TABLEAU ÉLECTRIQUE DE RÉGLAGE / MOTORÉDUCTEUR D'ATTAQUE DIRECT / POMPE À ENTRAÎNEMENT MAGNÉTIQUE / SÉCURITÉ EN CAS DE MANQUE D'EAU.
- ▶ **STAINLESS STEEL SOLEPLATE.**
BÂTI EN ACIER INOXYDABLE.
- ▶ **CONTROLLERS TO DETECT: LOW WATER LEVEL, TEMPERATURE RISE DUE TO MOTOR OVERLOAD OR FULL VAT.**
CONTRÔLES POUR DÉTECTION: MANQUE DE NIVEAU D'EAU, AUGMENTATION DE TEMPÉRATURE POUR CAUSE D'EFFORTS EXCESSIFS DANS LE MOTORÉDUCTEUR OU DE REMPLISSAGE DU RÉSERVOIR.



	 24 H	 10°C	 10°C	 21°C	 15°C	 (mm)	 (mm)	
SCALA 3000		3.300	3.000	Width 2.600 Depth 1.150 Height 1.300	Width 2.880 Depth 1.430 Height 1.620	FLAKE ICE -7°C Ice Temperature		

ACCESSORIES ACCESORIOS

INCLUDED			OPTIONAL (NOT INCLUDED)						
									
WATER INLET FILTER GASKET JOINT DE FILTRE D'ENTRÉE D'EAU	WATER INLET HOSE TUYAU D'ENTRÉE D'EAU	WATER OUTLET HOSE TUYAU D'ÉVACUATION	ICE DROP CHUTE TUYAU DE CHUTE DES GLAÇONS	SALT DOSING PUMP WITH TANK POMPE DE DOSAGE DE SEL AVEC DÉPÔT	REMOTE SWITCH INTERRUPTEUR À DISTANCE	REMOTE SWITCH & WEEKLY PROGRAMMER INTERRUPTEUR AVEC PROGRAMMEUR HEBDOMADAIRE	EXTERNAL STOP FULL BIN PHOTO CELL CAPTEUR D'ARRÊT EXTERNE PAR REMPLISSAGE	Y EXTENSION INOX EXTENSIÓN Y INOX	

RECOMMENDED BINS RÉSERVOIRS CONSEILLÉS



SS221 + SCALA 3000



SS422 + SCALA 3000

SCALA 3000

RIGHT SIDE VIEW
VUE LATÉRALE DROITE

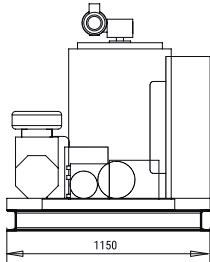

FRONTAL VIEW
VUE DE FACE

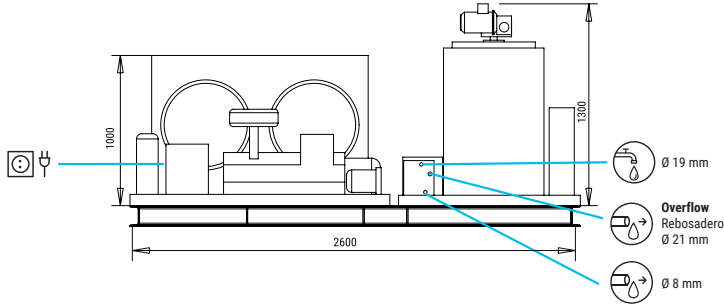

LEFT SIDE VIEW
VUE LATÉRALE GAUCHE

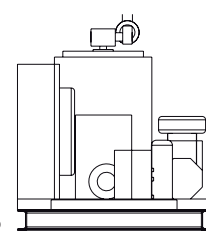

CENTRAL CROSS SECTION VIEW OF THE BASE
VUE DE LA BASE DEPUIS LA SECTION CENTRALE

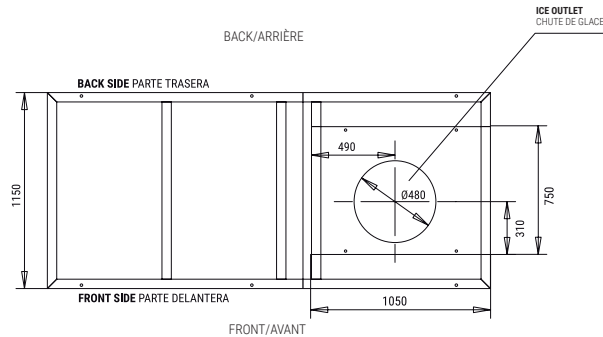

*All measurements in mm.
*Toutes les cotes sont en mm.

OPERATING CONDITIONS CONDITIONS DE FONCTIONNEMENT

PRODUCTION 50Hz PRODUCTION 50 Hz

Icon	Value	SCALA 3000					SCALA 3000				
		10°	15°	21°	30°	10°	15°	21°	30°		
⚡	±10% V	3300	3100	2700	2500	3069	2883	2511	2325		
🌡️	10°C/43°C	3270	3000	2600	2370	3041	2790	2418	2204		
🌡️	5°C/38°C	3100	2800	2400	2150	2883	2604	2232	2000		
💧	1 bar/6 bar	2550	2370	1950	1800	2372	2204	1814	1674		

MODÈLES

Model	Temp.EV. (°C)	ASHRAE CONDITIONS (W) (BTU/h)	(W) 43°C	(n.) (mm²)	FUSE	100 Kg (Kw/h)	(l/h)	HEAT REJECTED (W) (BTU/h)	(Kg)	(Kg)	(m³)
SCALA 3000	-22	16.500 56.300	12.350	5 6	32	7,3	125	19.800 67.560	660	740	6,68



ITV ICE MAKERS, S.L.
POL. IND. SECTOR 13, AVDA. DELS HOSTALERS, 2
46394 RIBARROJA DE TURIA, VALENCIA, SPAIN
PHONE: +34 96 166 75 75 | FAX: +34 96 166 81 00
info@itv.es | www.itv.es



SERVICE
SERVICE D'ASSISTANCE TECHNIQUE
service@itv.es
Skype: ITV.Service
+34 961 667 639
8:00AM | 7:00PM



Subject to certain limitations and exclusions. Only spare parts.
Sujet à limitations et exclusions.
Pièces de rechange uniquement.

